

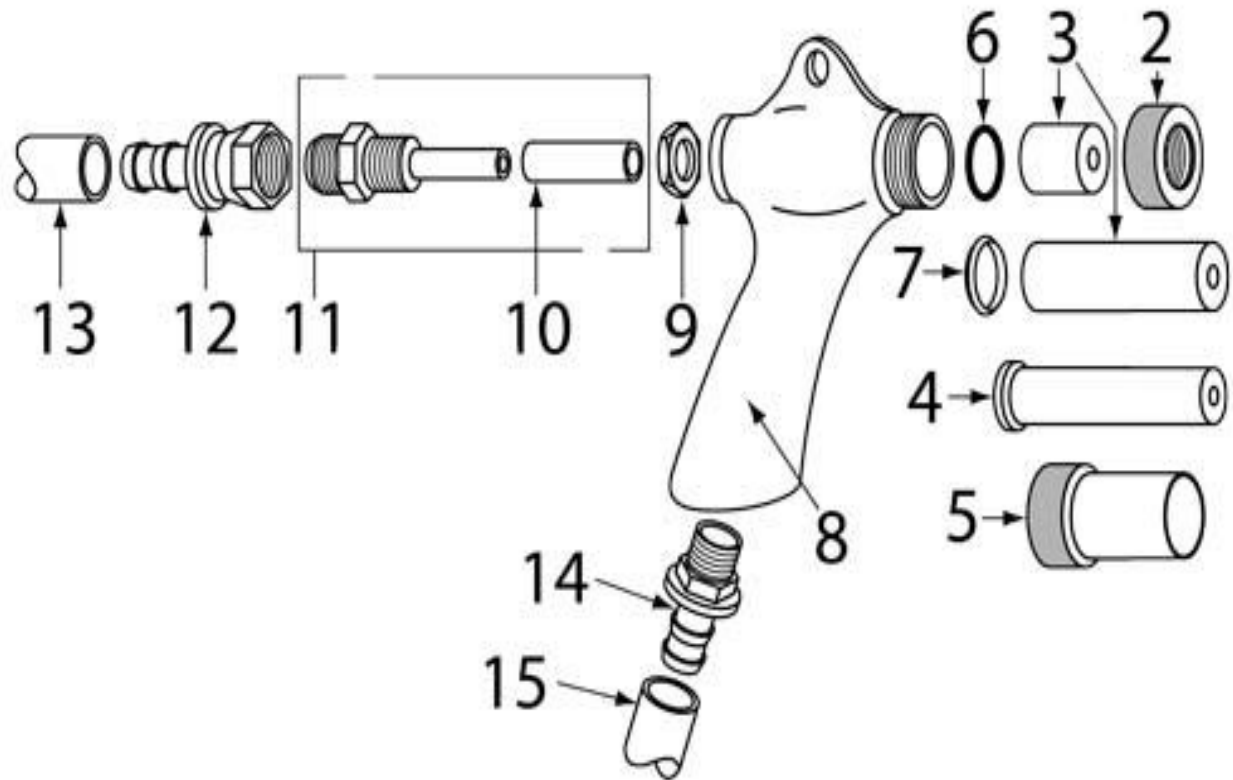











G-95 PARTS LIST



<p>1</p>		<p>G-95 GUN ASSEMBLY, W 1/8" ORIFICE, LESS NOZZLES</p>
<p>2</p>		<p>1347-1240 NUT, NOZZLE HOLDING</p>
<p>3</p>		<p>1348-380 NOZZLE, CERAMIC, STRAIGHT BORE, GUN INSERT, 5/16" BORE, 7/8" OD x 1-3/8" LENGTH</p>

G-95 PARTS LIST

3		<p><u>1348-450</u> NOZZLE, TUNGSTEN CARBIDE, STRAIGHT BORE, GUN INSERT, 5/16" BORE, 7/8" OD x 1-3/8" LENGTH</p>
3		<p><u>1348-630</u> NOZZLE, BORON CARBIDE, STRAIGHT BORE, GUN INSERT, 5/16" BORE, 7/8" OD x 1-3/8" LENGTH</p>
6		<p><u>1423-70</u> O-RING</p>
7		<p><u>1424-480</u> RETAINING RING, WIDE SPRAY</p>
8		<p><u>1237-10</u> GUN BODY, HAND</p>
9		<p><u>1347-1230</u> NUT, LOCKING</p>
10		<p><u>1450-50</u> SLEEVE, RUBBER</p>
11		<p><u>1701-290</u> ORIFICE, 1/8"</p>
12		<p><u>1219-300</u> FITTING, 1/2" SWIVEL x 1/2" PUSH LOK</p>

G-95 PARTS LIST